



AU Optonics Authorized Distributor

Specification

D' &\$< J B\$%'%

Version: >Ubi Ufm201'

Model Name: P320HVN01.1

Issue Date : 2013/1/25

() Preliminary Specifications

(*) Final Specifications

Customer Signature	Date	AUO	Date
Approved By _____		Approval By PM Director Paley Fang _____	
Note		Reviewed By RD Director Eugene CC Chen _____	
		Reviewed By Project Leader Alex HM Chen _____	
		Prepared By PM Rafael Lu _____	

Contents

No		
		CONTENTS
		RECORD OF REVISIONS
1		GENERAL DESCRIPTION
2		ABSOLUTE MAXIMUM RATINGS
3		ELECTRICAL SPECIFICATION
	3-1	ELECTRICAL CHARACTERISTICS
	3-2	INTERFACE CONNECTIONS
	3-3	SIGNAL TIMING SPECIFICATION
	3-4	SIGNAL TIMING WAVEFORM
	3-5	COLOR INPUT DATA REFERENCE
	3-6	POWER SEQUENCE
	3-7	BACKLIGHT SPECIFICATION
4		OPTICAL SPECIFICATION
5		MECHANICAL CHARACTERISTICS
	5-1	PLACEMENT SUGGESTION
6		RELIABILITY TEST ITEMS
7		INTERNATIONAL STANDARD
	7-1	SAFETY
	7-2	EMC
8		PACKING
	8-1	DEFINITION OF LABEL
	8-2	PACKING METHODS
	8-3	PALLET AND SHIPMENT INFORMATION
9		PRECAUTION
	9-1	MOUNTING PRECAUTIONS
	9-2	OPERATING PRECAUTIONS
	9-3	ELECTROSTATIC DISCHARGE CONTROL
	9-4	PRECAUTIONS FOR STRONG LIGHT EXPOSURE
	9-5	STORAGE
	9-6	HANDLING PRECAUTIONS FOR PROTECT FILM
	9-7	OPERATION CONDITION IN PID APPLICATION

1. General Description

This specification applies to the 31.5 inch Color TFT-LCD Module P320HVN01.0 This LCD module has a TFT active matrix type liquid crystal panel 1,920x1,080 pixels, and diagonal size of 31.5 inch. This module supports 1,920x1,080 mode. Each pixel is divided into Red, Green and Blue sub-pixels or dots which are arranged in vertical stripes. Gray scale or the brightness of the sub-pixel color is determined with a 8-bit gray scale signal for each dot.

The P320HVN01.0 has been designed to apply the 8-bit 2 channel LVDS interface method. It is intended to support displays where high brightness, wide viewing angle, high color saturation, and high color depth are very important.

* General Information

Items	Specification	Unit	Note
Active Screen Size	31.5	inch	
Display Area	698.4 (H) x 392.85(V)	mm	
Outline Dimension	727.4(H) x 429(V) x 26(D)	mm	D: Max
Driver Element	a-Si TFT active matrix		
Bezel Opening	705.6(H) x 400.1(V)	mm	
Display Colors	8 bits	Colors	
Number of Pixels	1,920x1,080	Pixel	
Pixel Pitch	0.3637 (H) x 0.3637 (W)	mm	
Pixel Arrangement	RGB vertical stripe		
Display Operation Mode	Normally Black		
Surface Treatment	Anti-Glare, 3H		Haze=2%
Rotate Function	Unachievable		Note 1

Note 1: Rotate Function refers to LCD display could be able to rotate.

2. Absolute Maximum Ratings

The followings are maximum values which, if exceeded, may cause faulty operation or damage to the unit

Item	Symbol	Min	Max	Unit	Conditions
Logic/LCD Drive Voltage	V_{DD}	-0.3	14	V_{DC}	Note 1
Input Voltage of Signal	V_{in}	-0.3	4	V_{DC}	Note 1
BLU Input Voltage	V_{DDB}	-0.3	28	V_{DC}	Note 1
BLU on/off Control Voltage	V_{BLON}	-0.3	7	V_{DC}	Note 1
BLU Brightness Control Voltage	V_{dim}	-0.3	7	V_{DC}	Note 1
Operating Temperature	TOP	0	+50	[°C]	Note 2
Operating Humidity	HOP	10	90	[%RH]	Note 2
Storage Temperature	TST	-20	+60	[°C]	Note 2
Storage Humidity	HST	10	90	[%RH]	Note 2
Panel Surface Temperature	PST		65	[°C]	Note 3

Note 1: Duration:50 msec.

Note 2 : Maximum Wet-Bulb should be 39°C and No condensation.

The relative humidity must not exceed 90% non-condensing at temperatures of 40°C or less. At temperatures greater than 40°C, the wet bulb temperature must not exceed 39°C.

Note 3: Surface temperature is measured at 50°C Dry condition

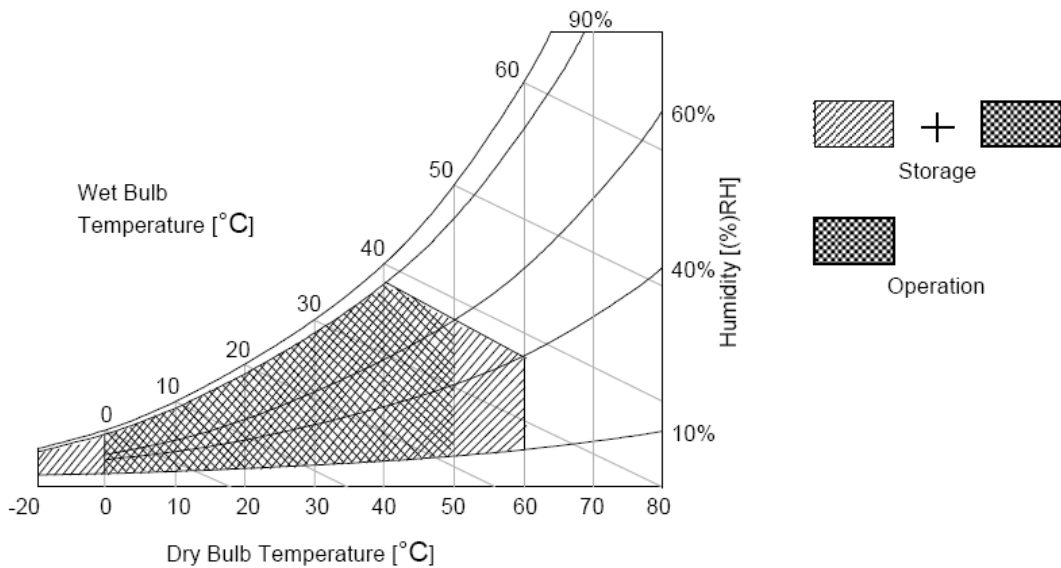

3. Electrical Specification

The P320HVN01.1 requires two power inputs. One is employed to power the LCD electronics and to drive the TFT array and liquid crystal. The other is to power Back Light Unit.

3.1 Electrical Characteristic

3.1.1: DC Characteristics

Parameter		Symbol	Value			Unit	Note
			Min.	Typ.	Max		
LCD							
Power Supply Input Voltage		V_{DD}	10.8	12	13.2	V_{DC}	
Power Supply Input Current		I_{DD}	--	0.39	0.56	A	1
Inrush Current		I_{RUSH}	--	--	5	A	2
Permissible Ripple of Power Supply Input Voltage		V_{RP}	--	--	$V_{DD} * 5\%$	mV_{pk-pk}	3
LVDS Interface	Input Differential Voltage	$ V_{ID} $	200	400	600	mV_{DC}	4
	Differential Input High Threshold Voltage	V_{TH}	+100	--	+300	mV_{DC}	4
	Differential Input Low Threshold Voltage	V_{TL}	-300	--	-100	mV_{DC}	4
	Input Common Mode Voltage	V_{ICM}	1.1	1.25	1.4	V_{DC}	4
CMOS Interface	Input High Threshold Voltage	V_{IH} (High)	2.7	--	3.3	V_{DC}	5
	Input Low Threshold Voltage	V_{IL} (Low)	0	--	0.6	V_{DC}	5
Backlight Power Consumption		P_{BL}		34.9	39.3	Watt	
Life time (MTTF)			50,000			Hours	8,9

3.1.2: AC Characteristics

Parameter		Symbol	Value			Unit	Note
			Min.	Typ.	Max		
LVDS Interface	Receiver Clock : Spread Spectrum Modulation range	F_{clk_ss}	F_{clk} -3%	--	F_{clk} +3%	MHz	6
	Receiver Clock : Spread Spectrum Modulation frequency	F_{ss}	30	--	200	KHz	6
	Receiver Data Input Margin Fclk = 85 MHz Fclk = 65 MHz	tRMG	-0.4 -0.5	-- --	0.4 0.5	ns	7

Note :

1. Test Condition:
 - (1) $V_{DD} = 12.0V$
 - (2) $F_v = 60Hz$
 - (3) $F_{clk} = \text{Max freq.}$

- (4) Temperature = 25 °C
- (5) Typ. Input current : White Pattern
Max. Input current: Heavy loading pattern defined by AUO

2. Measurement condition : Rising time = 400us

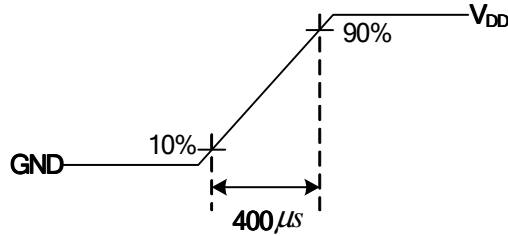

3. Test Condition:

- (1) The measure point of V_{RP} is in LCM side after connecting the System Board and LCM.
- (2) Under Max. Input current spec. condition.

4. $V_{ICM} = 1.25V$

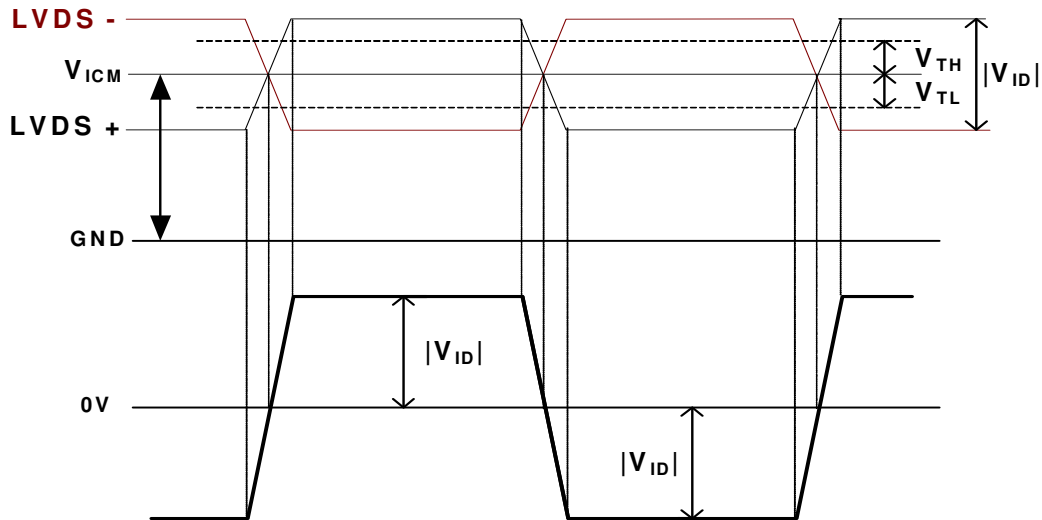

- 5. The measure points of V_{IH} and V_{IL} are in LCM side after connecting the System Board and LCM.
- 6. LVDS Receiver Clock SSCG (Spread spectrum clock generator) is defined as below figures.

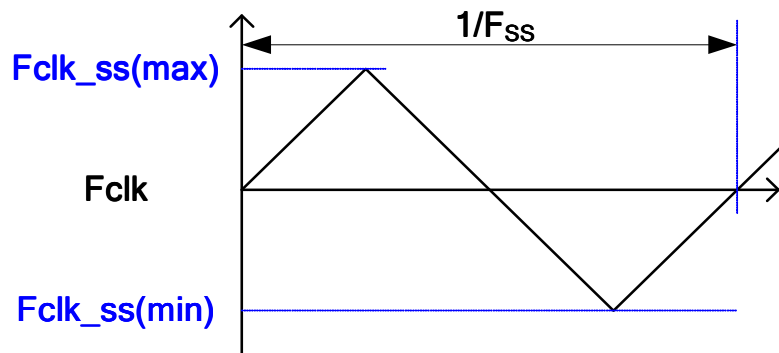

7. Receiver Data Input Margin

Parameter	Symbol	Rating			Unit	Note
		Min	Type	Max		
Input Clock Frequency	Fclk	Fclk (min)	--	Fclk (max)	MHz	$T=1/Fclk$
Input Data Position0	tRIP1	- tRMG	0	tRMG	ns	
Input Data Position1	tRIP0	$T/7- tRMG $	$T/7$	$T/7+ tRMG $	ns	
Input Data Position2	tRIP6	$2T/7- tRMG $	$2T/7$	$2T/7+ tRMG $	ns	
Input Data Position3	tRIP5	$3T/7- tRMG $	$3T/7$	$3T/7+ tRMG $	ns	
Input Data Position4	tRIP4	$4T/7- tRMG $	$4T/7$	$4T/7+ tRMG $	ns	
Input Data Position5	tRIP3	$5T/7- tRMG $	$5T/7$	$5T/7+ tRMG $	ns	
Input Data Position6	tRIP2	$6T/7- tRMG $	$6T/7$	$6T/7+ tRMG $	ns	

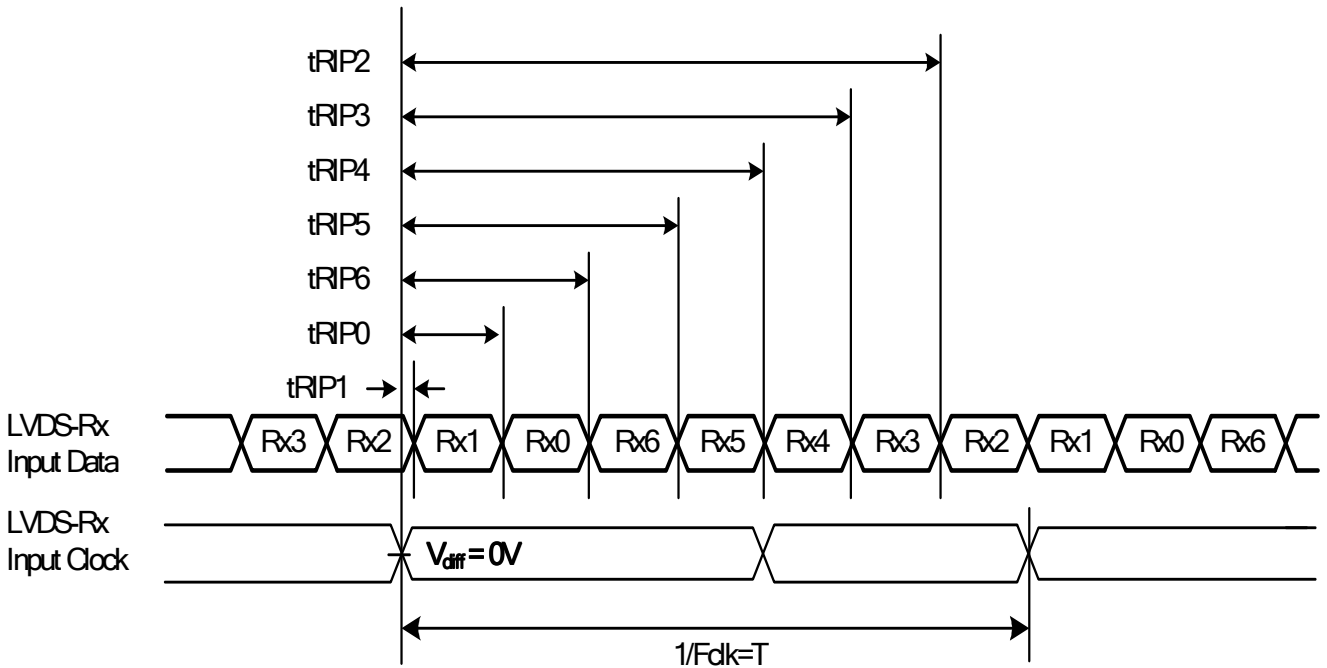

8.The relative humidity must not exceed 80% non-condensing at temperatures of 40°C or less. At temperatures greater than 40°C, the wet bulb temperature must not exceed 39°C. When operate at low temperatures, the brightness of LED will drop and the life time of LED will be reduced.

9.The lifetime (MTTF) is defined as the time which luminance of LED is 50% compared to its original value.
[Operating condition: Continuous operating at $T_a = 25\pm 2^\circ\text{C}$]

3.2 Interface Connections

- LCD connector: FI-RE51S-HF (JAE, LVDS connector)

PIN	Symbol	Description	PIN	Symbol	Description
1	V _{DD}	Power Supply, +12V DC Regulated	26	CH2_0+	LVDS Channel 2, Signal 0+
2	V _{DD}	Power Supply, +12V DC Regulated	27	CH2_1-	LVDS Channel 2, Signal 1-
3	V _{DD}	Power Supply, +12V DC Regulated	28	CH2_1+	LVDS Channel 2, Signal 1+
4	V _{DD}	Power Supply, +12V DC Regulated	29	CH2_2-	LVDS Channel 2, Signal 2-
5	V _{DD}	Power Supply, +12V DC Regulated	30	CH2_2+	LVDS Channel 2, Signal 2+
6	N.C.	No connection	31	GND	Ground
7	GND	Ground	32	CH2_CLK-	LVDS Channel 2, Clock -
8	GND	Ground	33	CH2_CLK+	LVDS Channel 2, Clock +
9	GND	Ground	34	GND	Ground
10	CH1_0-	LVDS Channel 1, Signal 0-	35	CH2_3-	LVDS Channel 2, Signal 3-
11	CH1_0+	LVDS Channel 1, Signal 0+	36	CH2_3+	LVDS Channel 2, Signal 3+
12	CH1_1-	LVDS Channel 1, Signal 1-	37	N.C.	No connection
13	CH1_1+	LVDS Channel 1, Signal 1+	38	N.C.	No connection
14	CH1_2-	LVDS Channel 1, Signal 2-	39	GND	Ground
15	CH1_2+	LVDS Channel 1, Signal 2+	40	SCL	EEPROM Serial Clock
16	GND	Ground	41	N.C.	No connection
17	CH1_CLK-	LVDS Channel 1, Clock -	42	N.C.	No connection (for AUO test only. Do not connect)
18	CH1_CLK+	LVDS Channel 1, Clock +	43	WP	EEPROM Write Protection High(3.3V) for Writable, Low(GND) for Protection
19	GND	Ground	44	SDA	EEPROM Serial Data
20	CH1_3-	LVDS Channel 1, Signal 3-	45	LVDS_SEL	High(3.3V) for NS, Open/Low(GND) for JEIDA
21	CH1_3+	LVDS Channel 1, Signal 3+	46	N.C.	No connection
22	N.C.	No connection	47	N.C.	No connection
23	N.C.	No connection	48	N.C.	No connection
24	GND	Ground	49	N.C.	No connection
25	CH2_0-	LVDS Channel 2, Signal 0-	50	N.C.	No connection
			51	HVS.	HVS

Note: N.C. : please leave this pin unoccupied. It can not be connected by any signal (Low/GND/High).

■ LVDS Option = High → NS

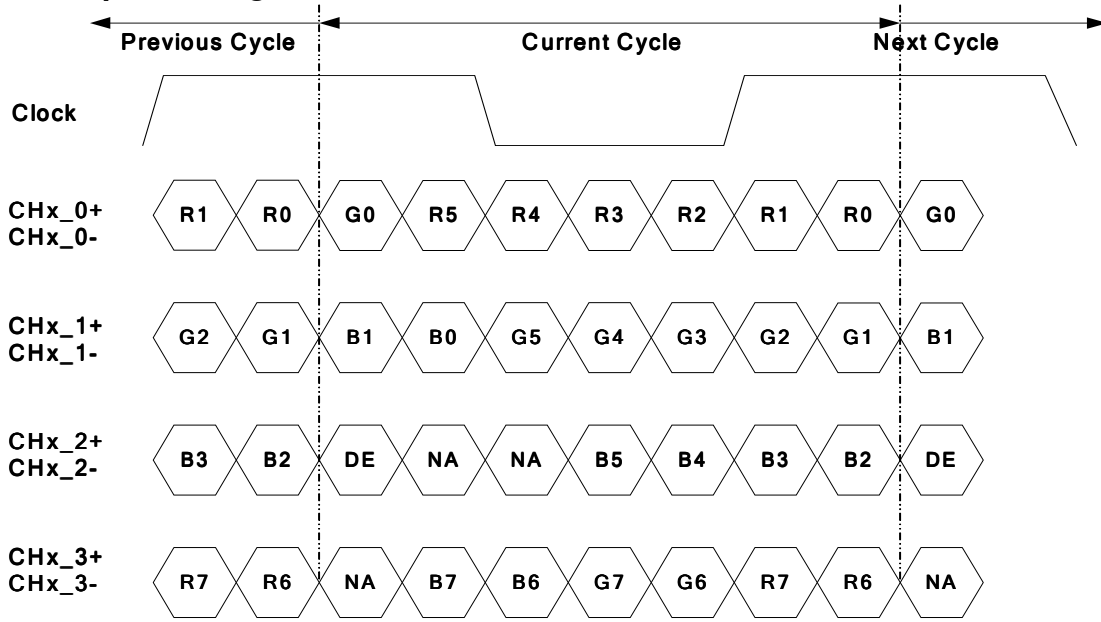

Note: x = 1, 2, 3, 4...

■ LVDS Option = Low/Open → JEIDA

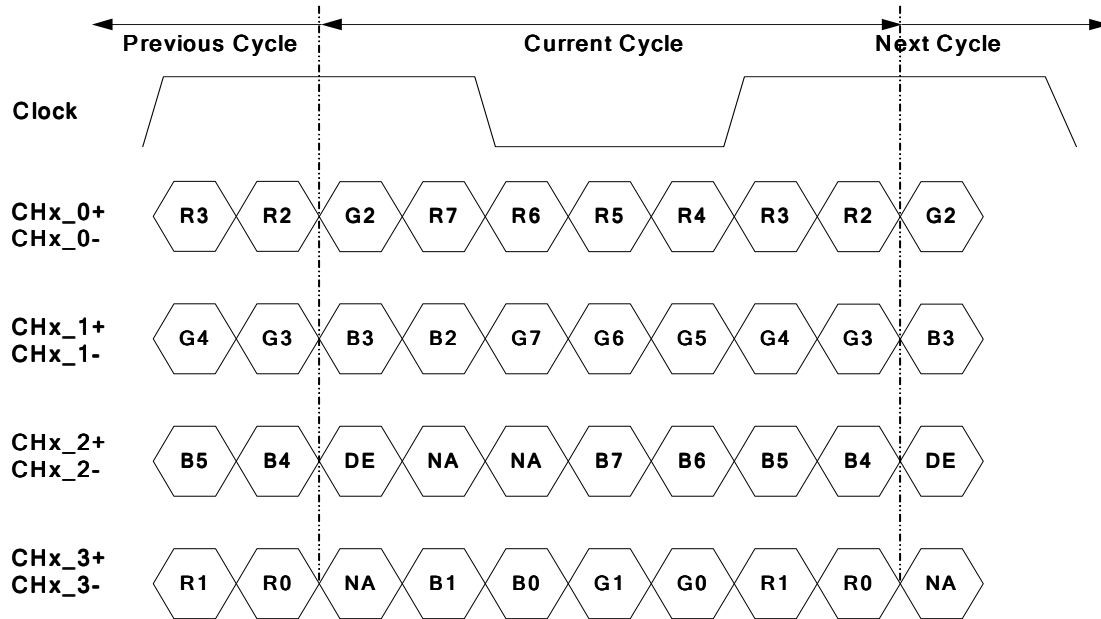

Note: x = 1, 2, 3, 4...

3.3 Signal Timing Specification

This is the signal timing required at the input of the user connector. All of the interface signal timing should be satisfied with the following specifications for its proper operation.

Timing Table (DE only Mode)

Signal	Item	Symbol	Min.	Typ.	Max	Unit
Vertical Section	Period	Tv	1096	1125	1480	Th
	Active	Tdisp (v)	1080			
	Blanking	Tblk (v)	16	45	400	Th
Horizontal Section	Period	Th	1030	1100	1325	Tclk
	Active	Tdisp (h)	960			
	Blanking	Tblk (h)	70	140	365	Tclk
Clock	Frequency	Fclk=1/Tclk	53	74.25	82	MHz
Vertical Frequency	Frequency	Fv	47	60	63	Hz
Horizontal Frequency	Frequency	Fh	60	67.5	73	KHz

Notes:

- (1) Display position is specific by the rise of DE signal only.
 Horizontal display position is specified by the rising edge of 1st DCLK after the rise of 1st DE, is displayed on the left edge of the screen.
- (2) Vertical display position is specified by the rise of DE after a "Low" level period equivalent to eight times of horizontal period. The 1st data corresponding to one horizontal line after the rise of 1st DE is displayed at the top line of screen.
- (3) If a period of DE "High" is less than 1920 DCLK or less than 1080 lines, the rest of the screen displays black.
- (4) The display position does not fit to the screen if a period of DE "High" and the effective data period do not synchronize with each other.

3.4 Signal Timing Waveforms

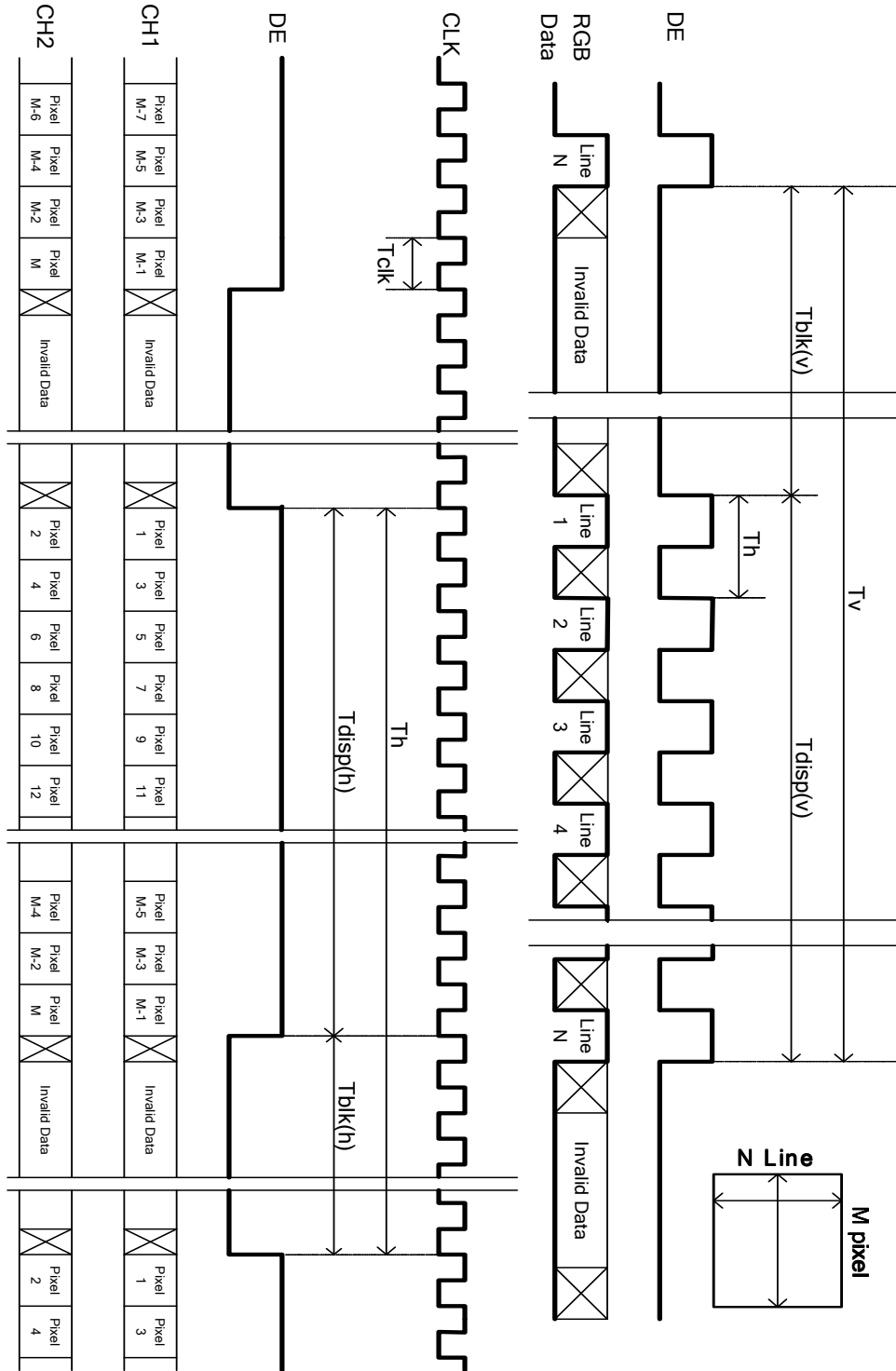

3.6 Power Sequence for LCD

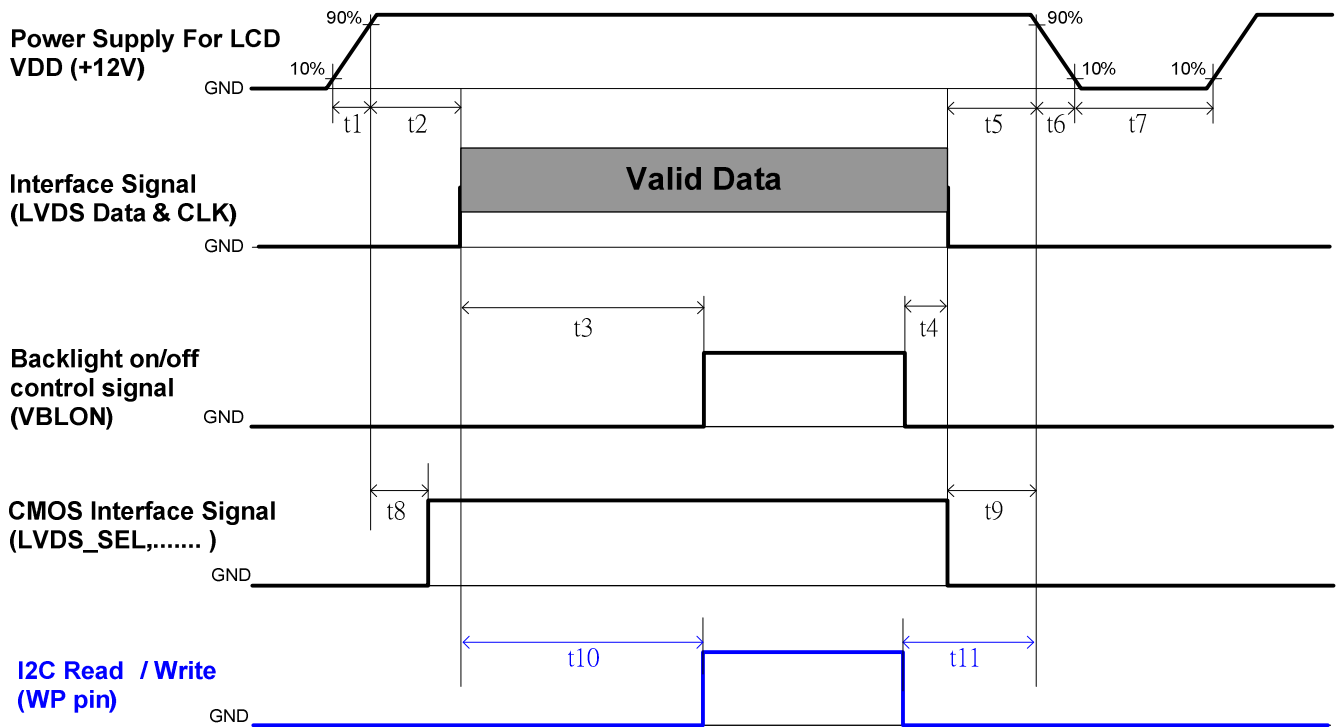

Parameter	Values			Unit
	Min.	Type.	Max.	
t1	0.4	---	30	ms
t2	0.1	---	50	ms
t3	450	---	---	ms
t4	0 ^{*1}	---	---	ms
t5	0	---	---	ms
t6	---	---	--- ^{*2}	ms
t7	500	---	---	ms
t8	10 ^{*4}	---	50	ms
t9	0	---	---	ms
t10	450	---	---	ms
t11	150 ^{*3}	---	---	ms

Note:

- (1) t4=0 : concern for residual pattern before BLU turn off.
- (2) t6 : voltage of VDD must decay smoothly after power-off. (customer system decide this value)
- (3) t11: the min value is decided by the download finish time of EDID 2Kbits.(when SCL over 30KHz)
- (4) When CMOS Interface signal is N.C. (no connection), opened in Transmitted end, t8 timing spec can be negligible.

3.7 Backlight Specification (independent driver board)

The backlight unit contains 1pcs light bar.

3.7.1 Electrical specification

	Item	Symbol	Condition	Spec			Unit	Note	
				Min	Typ	Max			
1	Input Voltage	V _{DDB}	-	22.8	24	25.2	VDC	-	
2	Input Current	I _{DDB}	V _{DDB} =24V		1.45	1.64	ADC	1	
3	Input Power	P _{DDB}	V _{DDB} =24V		34.9	39.3	W	1	
4	Inrush Current	I _{RUSH}	V _{DDB} =24V			5	Apeak	3	
5	Control signal voltage	V _{Signal}	Hi	V _{DDB} =24V	2	-	5.5	VDC	-
			Low		0	-	0.8		4
6	Control signal current	I _{Signal}	V _{DDB} =24V	-	-	1.5	mA	-	
7	External PWM Duty ratio (input duty ratio)	D_EPWM	V _{DDB} =24V	0	-	100	%	5	
8	External PWM Frequency	F_EPWM	V _{DDB} =24V	90	180	240	Hz	5	
9	DET status signal	DET	HI	V _{DDB} =24V	Open Collector			VDC	7
			Lo		0	-	0.8	VDC	7
10	Input Impedance	R _{in}	V _{DDB} =24V	300			Kohm	-	

Note 1: Dimming ratio= 100%, (Ta=25±5°C, Turn on for 45minutes)

Note 3: MAX input current at all operating mode, measurement condition Rising time = 20ms (V_{DDB}: 10%~90%)

Note 4: When BLU off (V_{DDB} = 24V , V_{BLON} = 0V) , I_{DDB} (max) = 0.1A

Note 5: Less than 5% dimming control is functional well and no backlight shutdown happened

Note 7: Normal: 0~0.8V ; Abnormal : Open collector

3.7.2 Input Pin Assignment

14pin pin assignment

Connector: CI0114M1HR0-NH(CviLux) or equivalent

Pin	Symbol	Description
1	VDDDB	Operating Voltage Supply, +24V DC regulated
2	VDDDB	Operating Voltage Supply, +24V DC regulated
3	VDDDB	Operating Voltage Supply, +24V DC regulated
4	VDDDB	Operating Voltage Supply, +24V DC regulated
5	VDDDB	Operating Voltage Supply, +24V DC regulated
6	BLGND	Ground and Current Return
7	BLGND	Ground and Current Return
8	BLGND	Ground and Current Return
9	BLGND	Ground and Current Return
10	BLGND	Ground and Current Return
11	DET	BLU status detection: Normal : 0~0.8V ; Abnormal : Open collector (Recommend Pull high R > 10K, VDD = 3.3V)
12	VBLON	BLU On-Off control: High/Open (2~5.5V) : BL On ; Low (0~0.8V/GND) : BL Off
13	NC	NC
14	PDIM(*)	External PWM (0%~100% Duty, open for 100%)

(Note*)

PWM Dimming range:



IF External PWM function less than 5% dimming ratio, Judge condition as below:

- (1) Backlight module must be lighted ON normally.
- (2) All protection function must work normally.
- (3) Uniformity and flicker could not be guaranteed

3.7.3 Power Sequence for Backlight

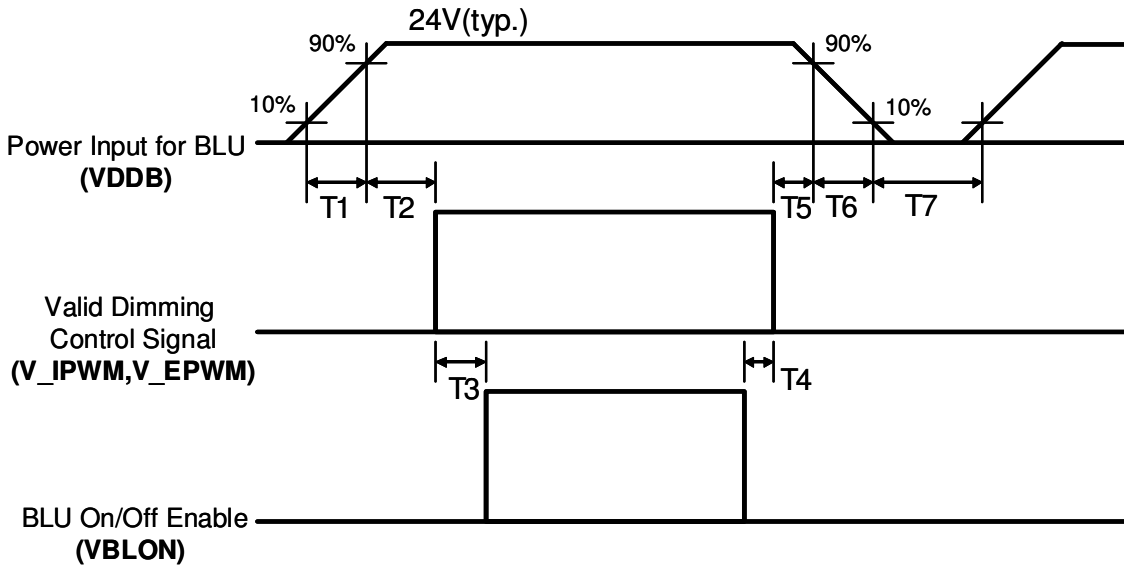

Dip condition

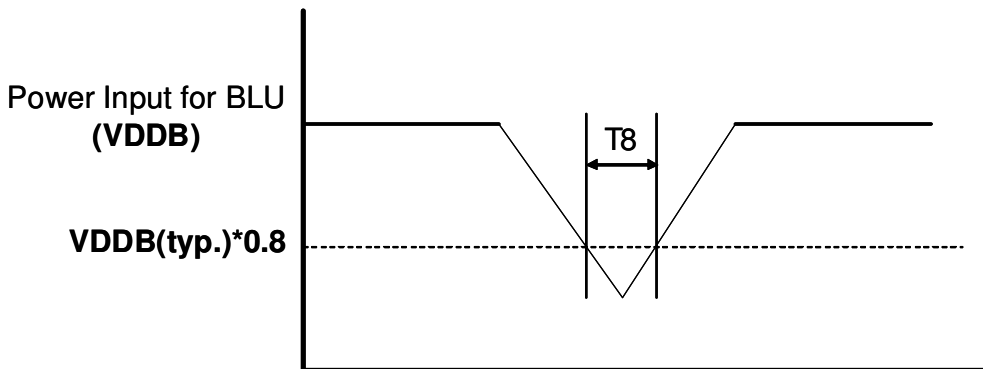

Parameter	Value			Units
	Min	Typ	Max	
T1	20	-	-	ms
T2	500	-	-	ms
T3	250	-	-	ms
T4	0	-	-	ms
T5	1	-	-	ms
T6	0	-	-	ms
T7	500	-	-	ms
T8	-	-	10	ms

4. Optical Specification

Optical characteristics are determined after the unit has been 'ON' and stable for approximately 45 minutes in a dark environment at 25°C. The values specified are at an approximate distance 50cm from the LCD surface at a viewing angle of ϕ and θ equal to 0°.

Fig.1 presents additional information concerning the measurement equipment and method.

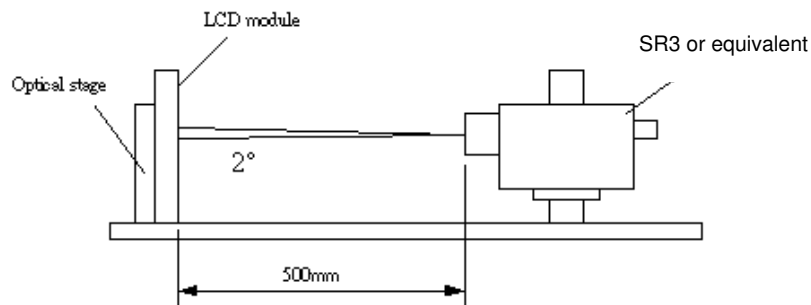

Parameter	Symbol	Values			Unit	Notes
		Min.	Typ.	Max		
Contrast Ratio	CR	2400	3000	--		1
Surface Luminance (White)	L_{WH}	280	350	--	cd/m ²	2
Luminance Variation	$\delta_{WHITE(9P)}$	--	--	1.33		3
Response Time (G to G)	T_{γ}	--	8	10	ms	4
Color Gamut	NTSC		72		%	
Color Coordinates						
<div style="border-left: 1px dashed black; border-right: 1px dashed black; padding: 0 5px;"> Red Green Blue White </div>	R_x	Typ.-0.03	0.640	Typ.+0.03		
	R_y		0.330			
	G_x		0.300			
	G_y		0.620			
	B_x		0.150			
	B_y		0.033			
	W_x		0.28			
W_y	0.29					
Viewing Angle						
<div style="border-left: 1px dashed black; border-right: 1px dashed black; padding: 0 5px;"> x axis, right($\phi=0^\circ$) x axis, left($\phi=180^\circ$) y axis, up($\phi=90^\circ$) y axis, down ($\phi=270^\circ$) </div>	θ_r	--	89	--	degree	5
	θ_l	--	89	--	degree	
	θ_u	--	89	--	degree	
	θ_d	--	89	--	degree	

Note:

1. Contrast Ratio (CR) is defined mathematically as:

$$\text{Contrast Ratio} = \frac{\text{Surface Luminance of } L_{on5}}{\text{Surface Luminance of } L_{off5}}$$

2. Surface luminance is luminance value at point 5 across the LCD surface 50cm from the surface with all pixels displaying white. From more information see FIG 2. LED input $V_{DDB} = 24V$, $I_{DDB} =$ Typical value (with driver board), $L_{WH} = L_{on5}$ where L_{on5} is the luminance with all pixels displaying white at center 5 location.

3. The variation in surface luminance, δ_{WHITE} is defined (center of Screen) as:

$$\delta_{WHITE(9P)} = \text{Maximum}(L_{on1}, L_{on2}, \dots, L_{on9}) / \text{Minimum}(L_{on1}, L_{on2}, \dots, L_{on9})$$

4. Response time T_{γ} is the average time required for display transition by switching the input signal for five luminance ratio (0%,25%,50%,75%,100% brightness matrix) and is based on $F_v = 60\text{Hz}$ to optimize.

Measured Response Time		Target				
		0%	25%	50%	75%	100%
Start	0%		0% to 25%	0% to 50%	0% to 75%	0% to 100%
	25%	25% to 0%		25% to 50%	25% to 75%	25% to 100%
	50%	50% to 0%	50% to 25%		50% to 75%	50% to 100%
	75%	75% to 0%	75% to 25%	75% to 50%		75% to 100%
	100%	100% to 0%	100% to 25%	100% to 50%	100% to 75%	

T_{γ} is determined by 10% to 90% brightness difference of rising or falling period. (As illustrated)

The response time is defined as the following figure and shall be measured by switching the input signal for “any level of gray(bright)” and “any level of gray(dark)”.

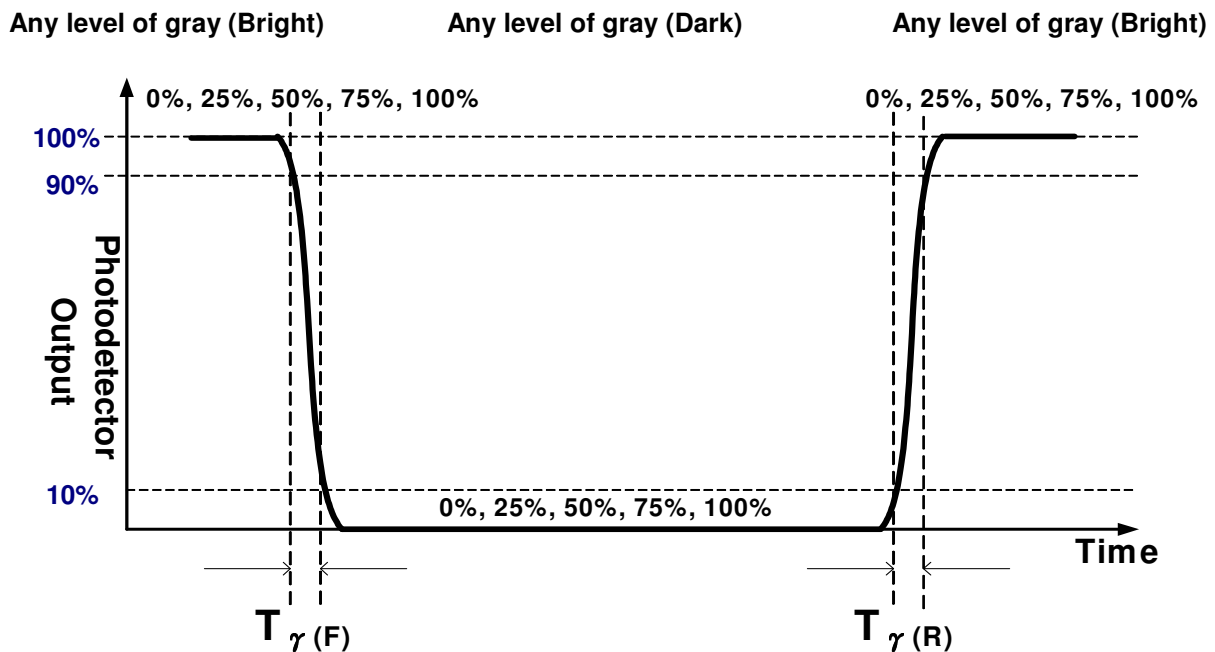
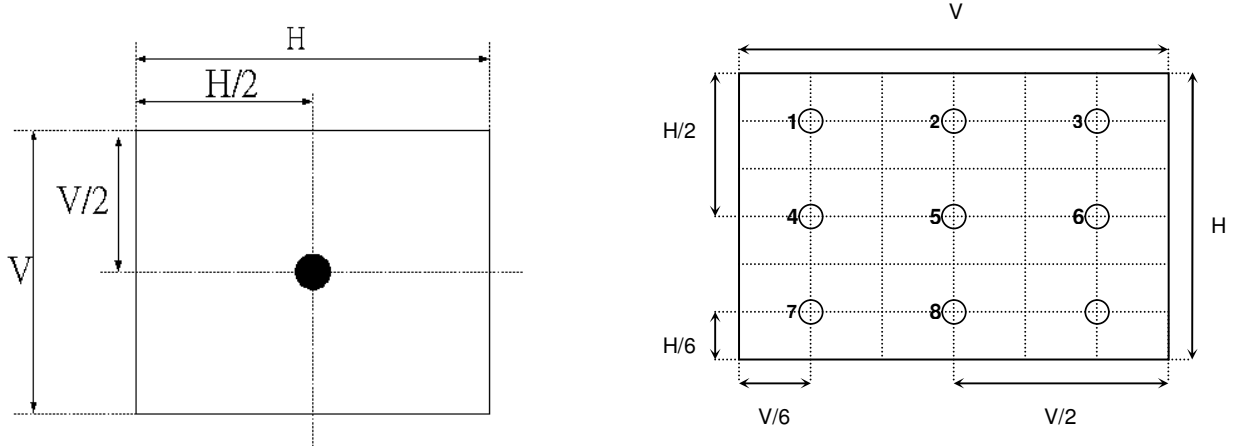
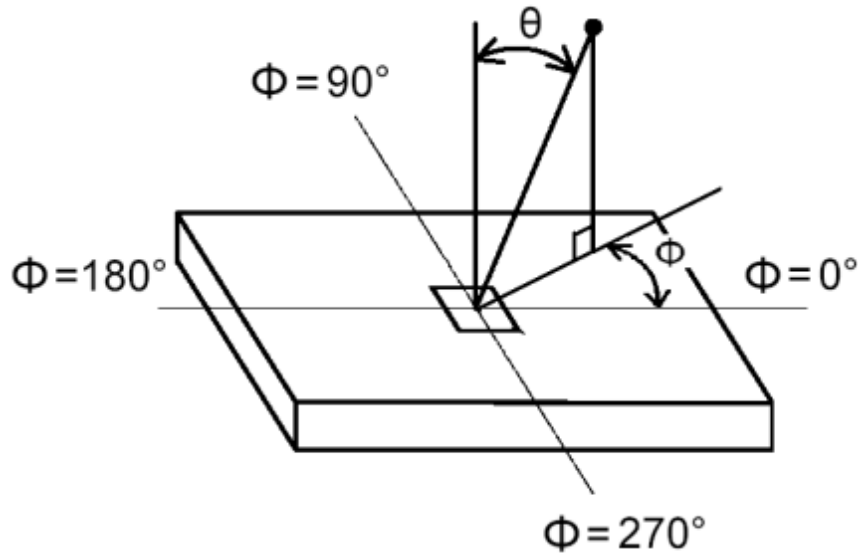

FIG. 2 Luminance



5. Viewing angle is the angle at which the contrast ratio is greater than 10. The angles are determined for the horizontal or x axis and the vertical or y axis with respect to the z axis which is normal to the LCD surface. For more information see FIG3.

FIG.3 Viewing Angle



5. Mechanical Characteristics

The contents provide general mechanical characteristics for the model P320HVN01.0. In addition the figures in the next page are detailed mechanical drawing of the LCD.

Item		Dimension	Unit	Note
Outline Dimension	Horizontal	727.4	mm	
	Vertical	429	mm	
	Depth (Dmin)	9.9	mm	to rear
	Depth (Dmax)	26	mm	
Weight	5150(TYP.) / 5250(MAX.)		g	

5.1 Placement Suggestions

1. Landscape Mode: The default placement is T-Con Side on the upper side and image will be shown upright via viewing from the front.

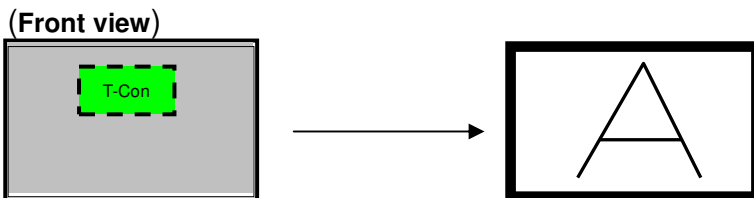

6. Reliability Test Items

	Test Item	Q'ty	Condition
1	High temperature storage test	3	60°C, 300hrs
2	Low temperature storage test	3	-20°C, 300hrs
3	High temperature operation test	3	50°C, 300hrs
4	Low temperature operation test	3	-5°C, 300hrs
5	Vibration test (non-operation)	3	Wave form: random Vibration level : 1.0G RMS Bandwidth : 10-300Hz Duration : X,Y,Z 10min per axes X,Y,Z: Horizontal, face up
6	Shock test (non-operation)	3	Shock level 50G ,20ms ±X,Y,Z axis Waveform: half sine wave Direction: One time each direction
7	Vibration test (With carton)	1CTN/7PCS	Random wave (1.05Grms 10~200Hz) Duration : X,Y,Z 10min per axes
8	Drop test (With carton)	1CTN/7PCS	Height: 30.5 cm (ASTMD4169-I) 1 corner, 3 edges, 6 surfaces (refer ASTM D 5276)

7. International Standard

7.1 Safety

- (1) UL 60950-1, 2007, Standard for Safety of Information Technology Equipment Including electrical Business Equipment.
- (2) IEC 60950-1 : 2005, Standard for Safety of International Electrotechnical Commission
- (3) EN 60950 : 2006+A11, European Committee for Electrotechnical Standardization (CENELEC), EUROPEAN STANDARD for Safety of Information Technology Equipment Including Electrical Business Equipment.

7.2 EMC

- (1) ANSI C63.4 "Methods of Measurement of Radio-Noise Emissions from Low-Voltage Electrical and Electrical Equipment in the Range of 9kHz to 40GHz. "American National standards Institute(ANSI), 1992
- (2) C.I.S.P.R "Limits and Methods of Measurement of Radio Interface Characteristics of Information Technology Equipment." International Special committee on Radio Interference.
- (3) EN 55022 "Limits and Methods of Measurement of Radio Interface Characteristics of Information Technology Equipment." European Committee for Electrotechnical Standardization. (CENELEC), 1998



8. Packing

8-1 DEFINITION OF LABEL:

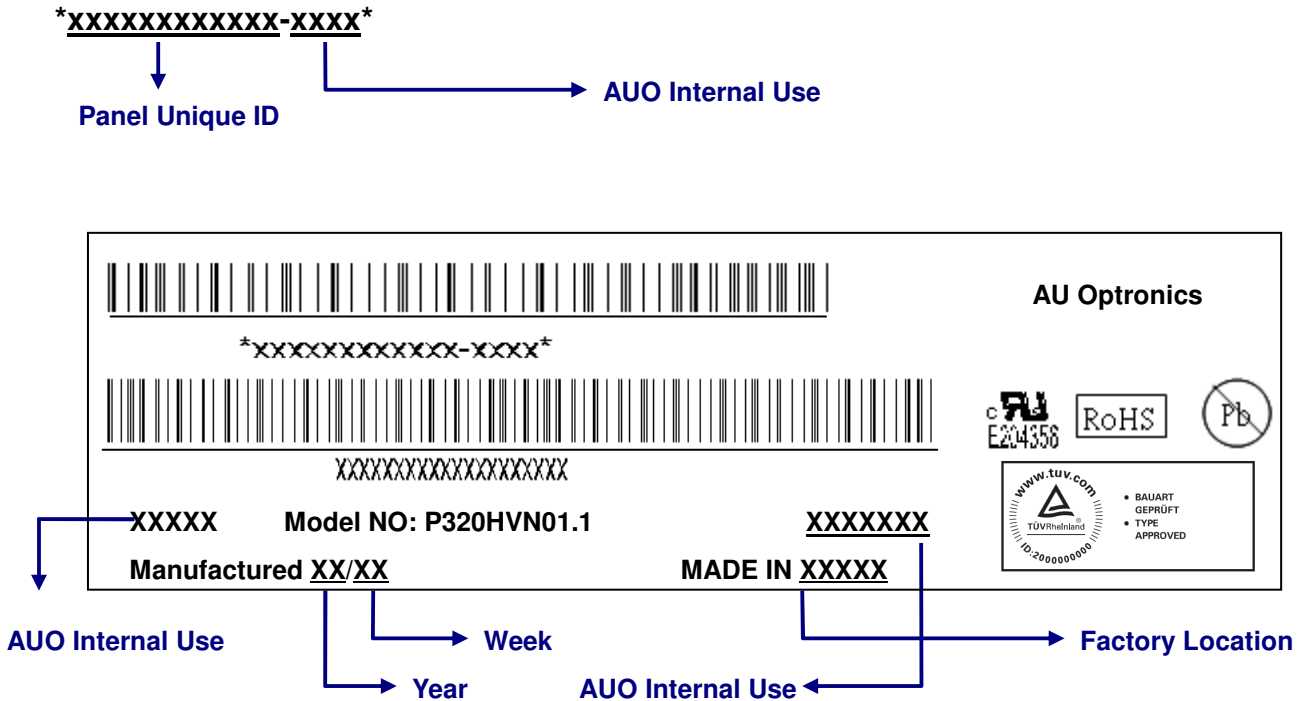
A. Panel Label:



Green mark description

- (1) For Pb Free Product, AUO will add  for identification.
- (2) For RoHs compatible products, AUO will add  for identification.

Note: The green Mark will be present only when the green documents have been ready by AUO internal green team. (definition of green design follows the AUO green design checklist.)

B. Carton Label:

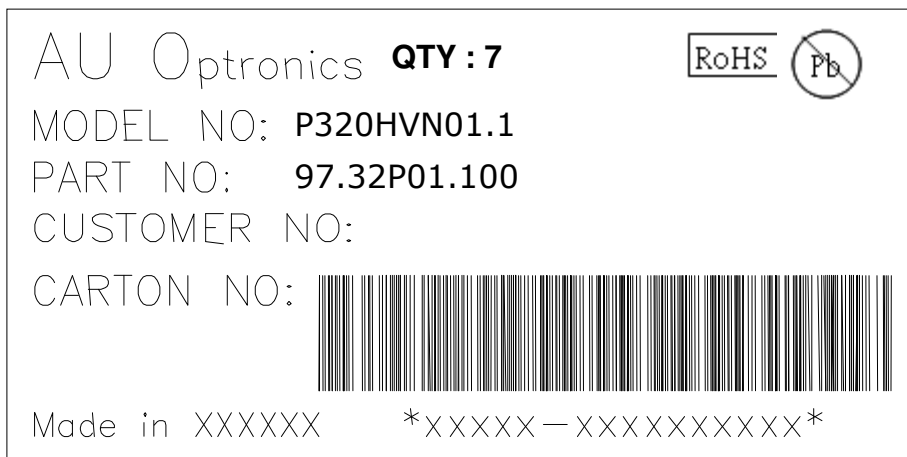

8-2 PACKING METHODS:

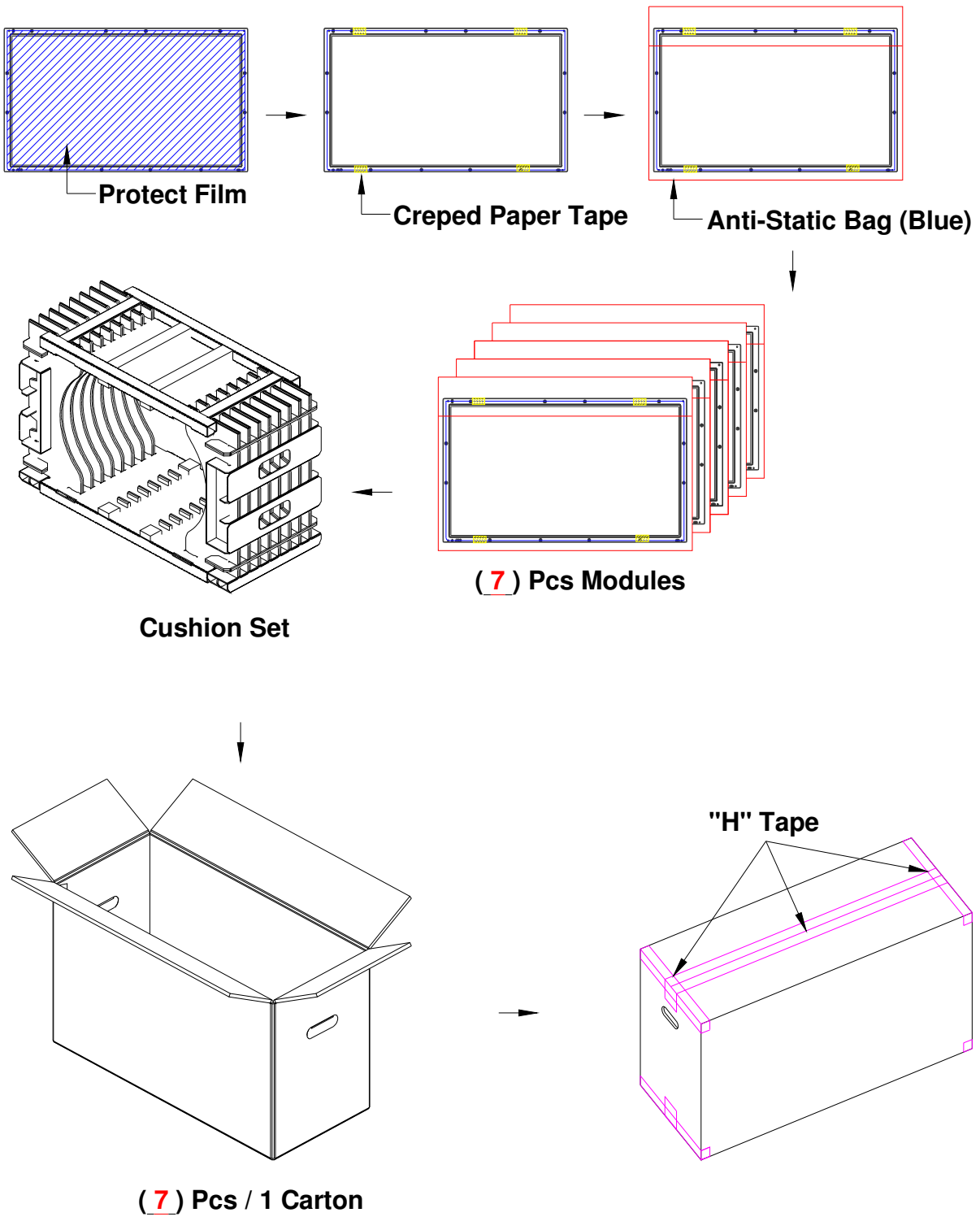

8-3 Pallet and Shipment Information

Item	Specification			Packing Remark
	Qty.	Dimension	Total Weight (kg)	
Packing BOX	7pcs/box	820(L)*376(W)*535(H)	40.09kg	Box = 1.82kg Cushion = 2.22kg
Pallet	1	1150(L)*840(W)*132(H)	15kg	
Boxes per Pallet	A. 3 boxes/pallet B. 6 boxes/pallet			
Panels per Pallet	A. 21pcs/pallet B. 42 boxes/pallet			
Pallet after packing (40' container)	56	A. 1150(L)*840(W)*667(H) B. 1150(L)*840(W)*1202(H)	A. 135.27kg B. 255.54kg	

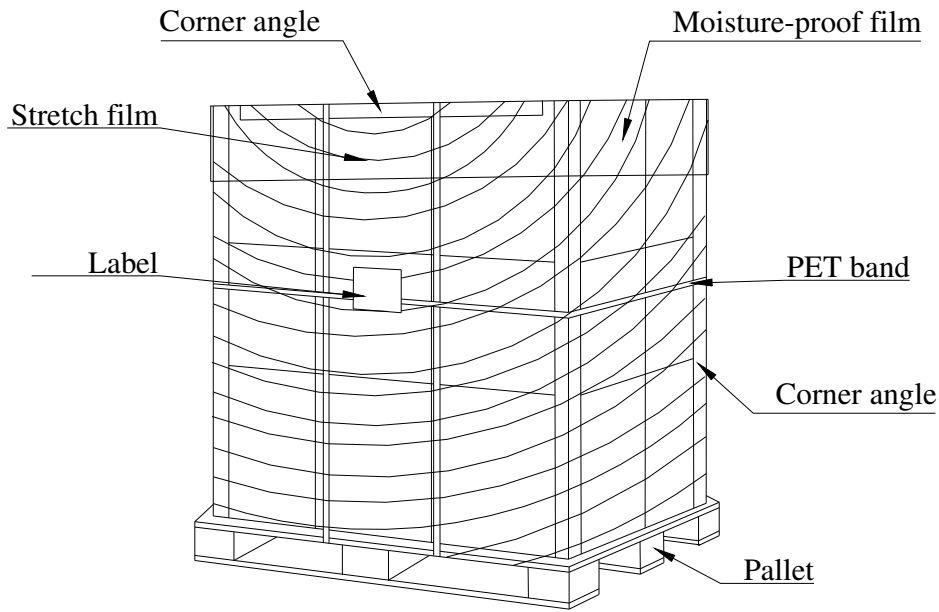

9. PRECAUTIONS

Please pay attention to the followings when you use this TFT LCD module.

9-1 MOUNTING PRECAUTIONS

- (1) You must mount a module using holes arranged in four corners or four sides.
- (2) You should consider the mounting structure so that uneven force (ex. twisted stress) is not applied to module. And the case on which a module is mounted should have sufficient strength so that external force is not transmitted directly to the module.
- (3) Please attach the surface transparent protective plate to the surface in order to protect the polarizer. Transparent protective plate should have sufficient strength in order to resist external force.
- (4) You should adopt radiation structure to satisfy the temperature specification.
- (5) Acetic acid type and chlorine type materials for the cover case are not desirable because the former generates corrosive gas of attacking the polarizer at high temperature and the latter cause circuit broken by electro-chemical reaction.
- (6) Do not touch, push or rub the exposed polarizer with glass, tweezers or anything harder than HB pencil lead. And please do not rub with dust clothes with chemical treatment. Do not touch the surface of polarizer for bare hand or greasy cloth. (Some cosmetics are detrimental to the polarizer.)
- (7) When the surface becomes dusty, please wipe gently with absorbent cotton or other soft materials like chamois soaks with petroleum benzene. Normal-hexane is recommended for cleaning the adhesives used to attach front/ rear polarizer. Do not use acetone, toluene and alcohol because they cause chemical damage to the polarizer.
- (8) Wipe off saliva or water drops as soon as possible. Their long time contact with polarizer causes deformations and color fading.
- (9) Do not open the case because inside circuits do not have sufficient strength.

9-2 OPERATING PRECAUTIONS

- (1) The device listed in the product specification sheets was designed and manufactured for TV application
- (2) The spike noise causes the mis-operation of circuits. It should be lower than following voltage:
 $V = \pm 200\text{mV}$ (Over and under shoot voltage)
- (3) Response time depends on the temperature. (In lower temperature, it becomes longer..)
- (4) Brightness of CCFL depends on the temperature. (In lower temperature, it becomes lower.) And in lower temperature, response time (required time that brightness is stable after turned on) becomes longer.
- (5) Be careful for condensation at sudden temperature change. Condensation makes damage to polarizer or electrical contacted parts. And after fading condensation, smear or spot will occur.
- (6) When fixed patterns are displayed for a long time, remnant image is likely to occur.
- (7) Module has high frequency circuits. Sufficient suppression to the electromagnetic interference shall

be done by system manufacturers. Grounding and shielding methods may be important to minimize the interface.

9-3 ELECTROSTATIC DISCHARGE CONTROL

Since a module is composed of electronic circuits, it is not strong to electrostatic discharge. Make certain that treatment persons are connected to ground through wristband etc. And don't touch interface pin directly.

9-4 PRECAUTIONS FOR STRONG LIGHT EXPOSURE

Strong light exposure causes degradation of polarizer and color filter.

9-5 STORAGE

When storing modules as spares for a long time, the following precautions are necessary.

- (1) Store them in a dark place. Do not expose the module to sunlight or fluorescent light. Keep the temperature between 5°C and 35°C at normal humidity.
- (2) The polarizer surface should not come in contact with any other object. It is recommended that they be stored in the container in which they were shipped.

9-6 HANDLING PRECAUTIONS FOR PROTECTION FILM

- (1) The protection film is attached to the bezel with a small masking tape. When the protection film is peeled off, static electricity is generated between the film and polarizer. This should be peeled off slowly and carefully by people who are electrically grounded and with well ion-blown equipment or in such a condition, etc.
- (2) When the module with protection film attached is stored for a long time, sometimes there remains a very small amount of glue still on the bezel after the protection film is peeled off.
- (3) You can remove the glue easily. When the glue remains on the bezel or its vestige is recognized, please wipe them off with absorbent cotton waste or other soft material like chamois soaked with normal-hexane.

9-7 Operating Condition in PID Application

- (1) If the continuous static display is required, periodically inserting a motion picture is strongly recommended.
- (2) Recommend to periodically change the background color and background image.
- (3) Recommend not to continuously operate over 20 hours a day.
- (4) Recommend to adopt one of the following actions after long time display.
 - I. Running the screen saver (motion picture or black pattern)
 - II. Power off the system for a while
- (5) Try not to run the LCD in a closed environment. Suitable venting on the system cover would be helpful for cooling.

(6) It is better to adapt active cooling with fans for long time displaying, especially for high luminance LCD model.