

LSC880M3A

Infrared Emitting Diode

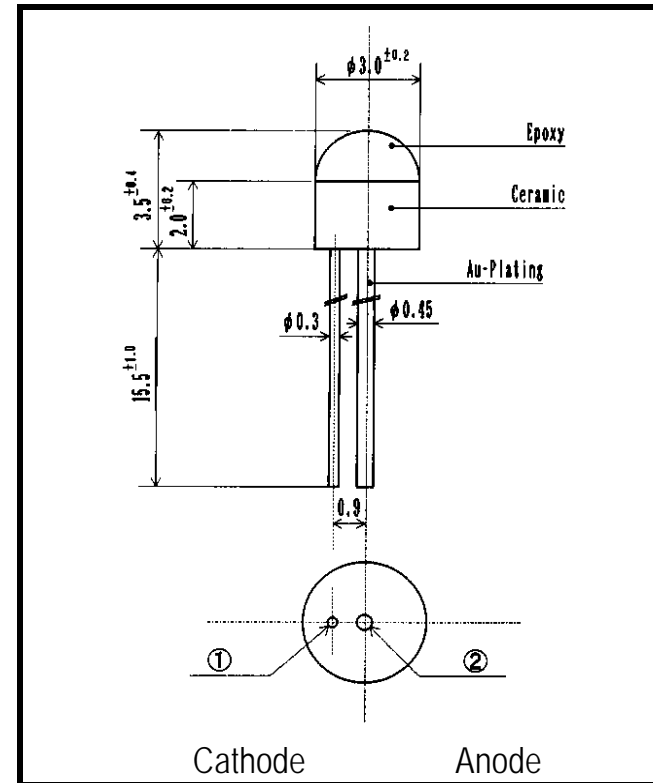

- FEATURES**
- High-output Power
 - Compact
 - High Reliability
- APPLICATIONS**
- Optical Switches
 - Optical Sensors

1. ABSOLUTE MAXIMUM RATINGS (Ta=25 °C)

ITEM	SYMBOL	RATINGS	UNIT
Forward Current (DC)	IF	50	mA
Forward Current (Pulse)*1	IFP	0.5	A
Reverse Voltage	VR	5	V
Power Dissipation	PD	100	mW
Operating Temp.	Topr	-20 TO 85	
Storage Temp.	Tstg	-30 TO 100	
Junction Temp.	Tj	100	
Lead Soldering Temp.*2	Tls	260	

*1:Tw=10uS,T=10mS

*2:Time 5 Sec max,Position:Up to 3mm from the body

2. ELECTRICAL & OPTICAL CHARACTERISTICS (Ta=25 °C)

ITEM	SYMBOL	CONDITIONS	MIN	TYP	MAX	UNIT
Power Output	PO	IF=20mA		4.5		mW
Forward Voltage	VF	IF=20mA		1.3	1.6	V
Reverse Current	IR	VR=5V			10	μA
Peak Wavelength	p	IF=20mA		880		nm
Spectral Line Half Width		IF=20mA		60		nm
Half Intensity Beam Angle		IF=20mA		±80		deg.
Rise Time	Tr	IFP=50mA		1.5		μS
Fall Time	Tf	IFP=50mA		0.8		μS
Junction Capacitance	Cj	1MHz, V=0V		15		pF
Temp. Coefficient of PO	P/T	IF=10mA		-0.5		%/
Temp. Coefficient of VF	V/T	IF=10mA		-1.5		mV/

Cathode Anode
Dimensions (Unit:mm)

SPECTRAL OUTPUT

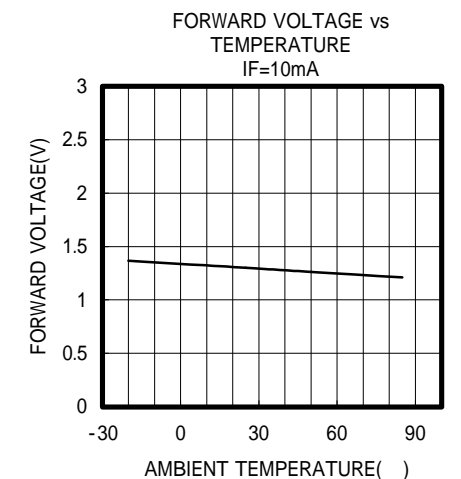
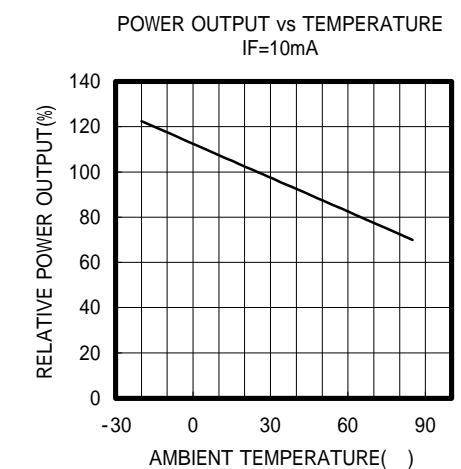
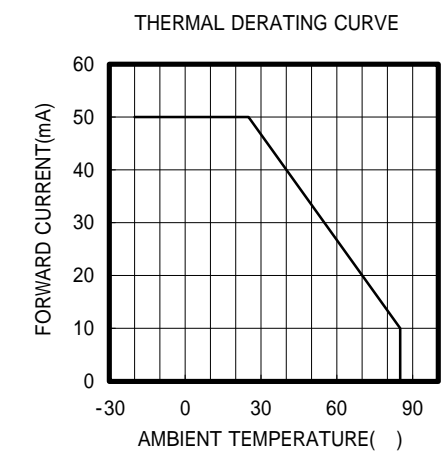
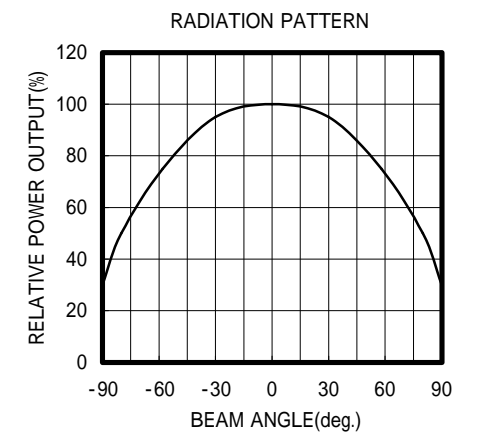
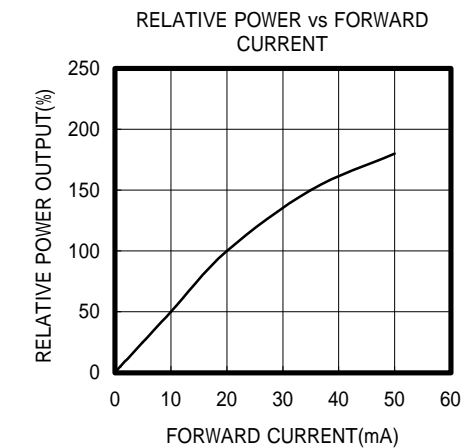
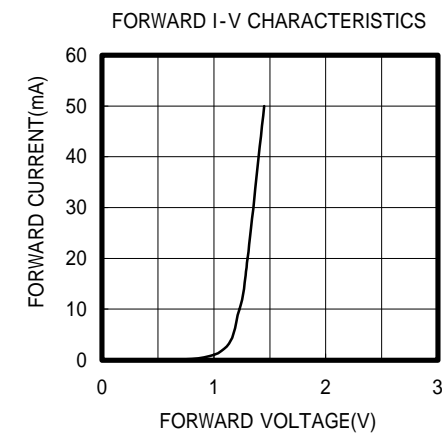
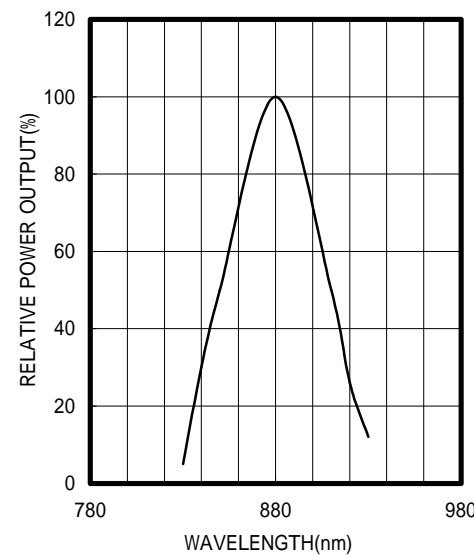

OPTRANS

2-6-11 MASUKATA, TAMA-KU, KAWASAKI 214-0032. JAPAN
TEL.81(44)932-6491 / FAX.81(44)932-8281
E-mail: oprans@mb.kcom.ne.jp