

VS525TM

Visible Light Emitting Diode

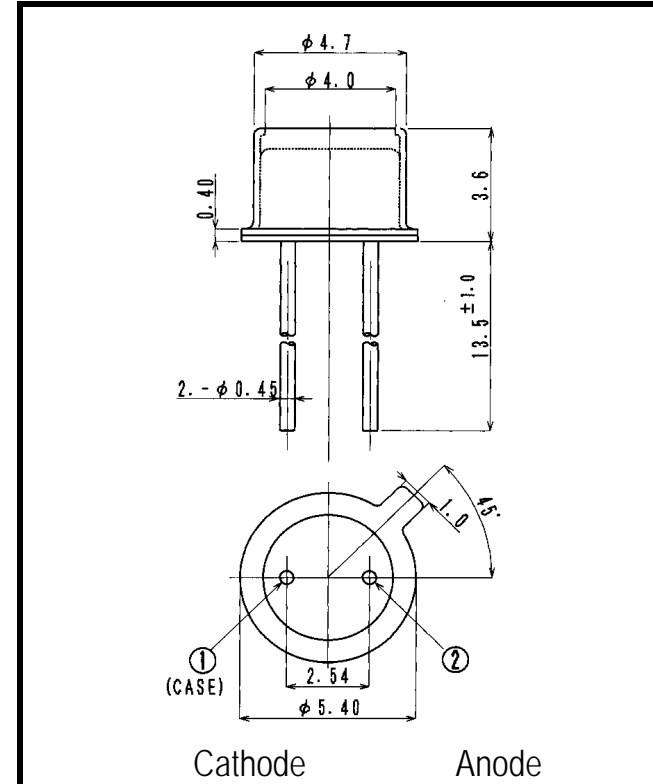
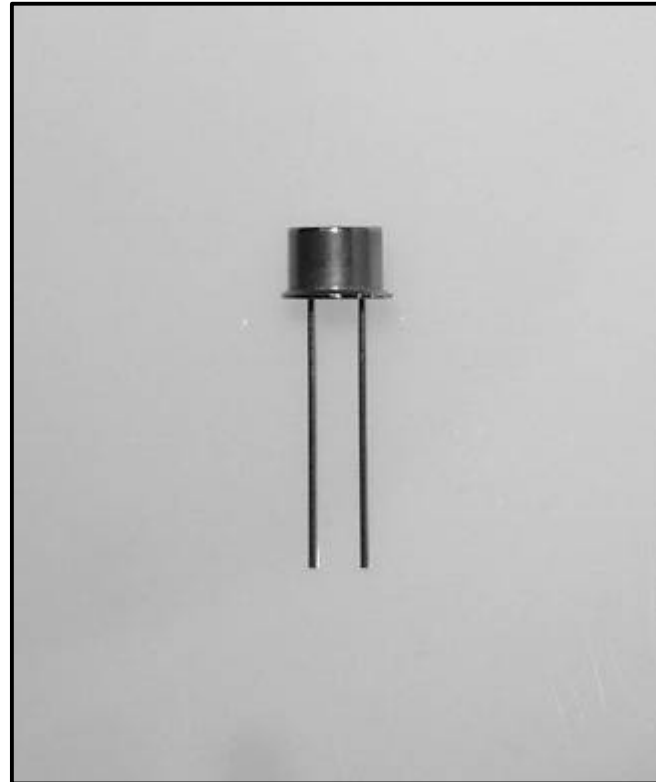

- FEATURES**
- High-output Power
 - High Reliability
- APPLICATIONS**
- Color Sensor (Money-bill)
 - Paper Sensor (Money-bill)
 - Bar code Reader
 - Fiber Applications

1. ABSOLUTE MAXIMUM RATINGS (Ta=25 °C)

ITEM	SYMBOL	RATINGS	UNIT
Forward Current (DC)	IF	30	mA
Forward Current (Pulse)*1	IFP	0.3	A
Reverse Voltage	VR	5	V
Power Dissipation	PD	120	mW
Operating Temp.	Topr	-20 TO 85	
Storage Temp.	Tstg	-30 TO 100	
Junction Temp.	Tj	100	
Lead Soldering Temp.*2	Tls	260	

*1:Tw=10uS,T=10mS

*2:Time 5 Sec max,Position:Up to 3mm from the body

2. ELECTRICAL & OPTICAL CHARACTERISTICS (Ta=25 °C)

ITEM	SYMBOL	CONDITIONS	MIN	TYP	MAX	UNIT
Power Output	PO	IF=20mA	0.5	0.9		mW
Forward Voltage	VF	IF=20mA		3.5	4.0	V
Reverse Current	IR	VR=5V			100	μA
Peak Wavelength	λ	IF=20mA		525		nm
Spectral Line Half Width		IF=20mA		45		nm
Half Intensity Beam Angle		IF=20mA		±20		deg.
Rise Time	Tr	IFP=20mA		-		nS
Fall Time	Tf	IFP=20mA		-		nS
Junction Capacitance	Cj	1MHz, V=0V		25		pF
Temp. Coefficient of PO	P/T	IF=10mA		-0.5		%/
Temp. Coefficient of VF	V/T	IF=10mA		-4.0		mV/

SPECTRAL OUTPUT

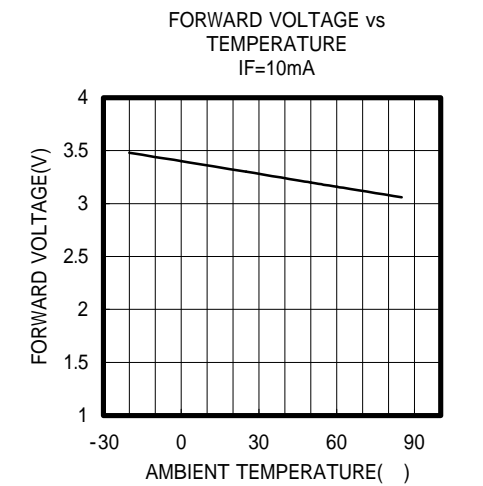
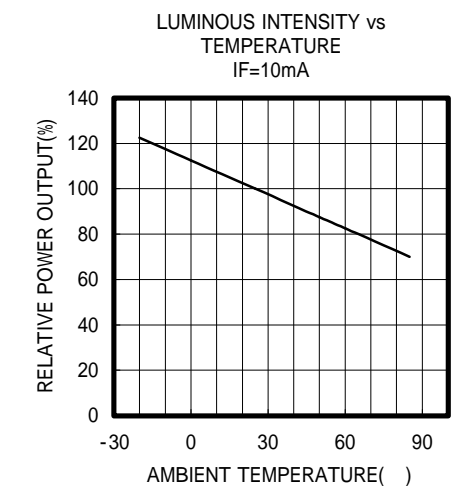
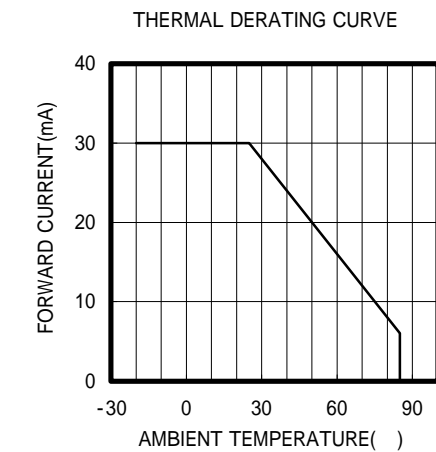
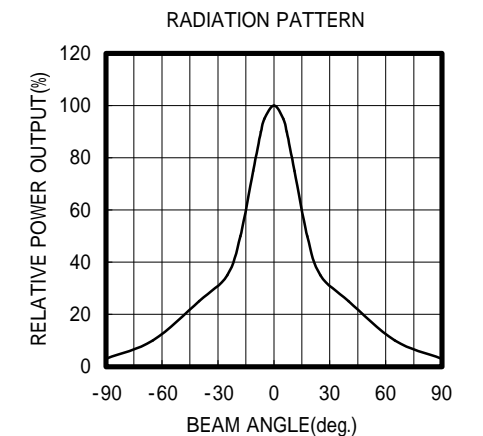
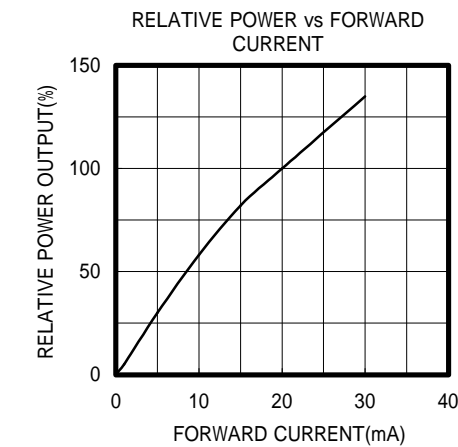
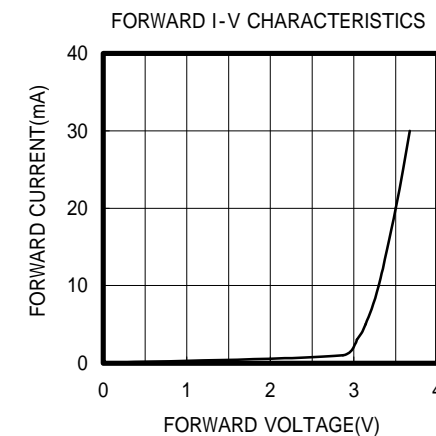
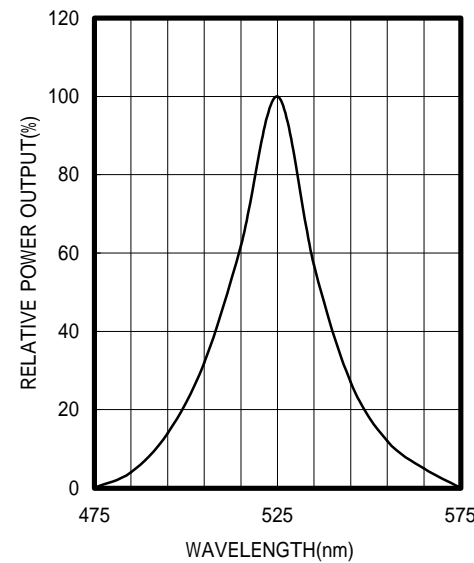

OPTRANS

2-6-11 MASUKATA, TAMA-KU, KAWASAKI 214-0032. JAPAN
TEL.81(44)932-6491 / FAX.81(44)932-8281
E-mail optrans@mb.kcom.ne.jp