

# VSF472N2

# Visible Light Emitting Diode

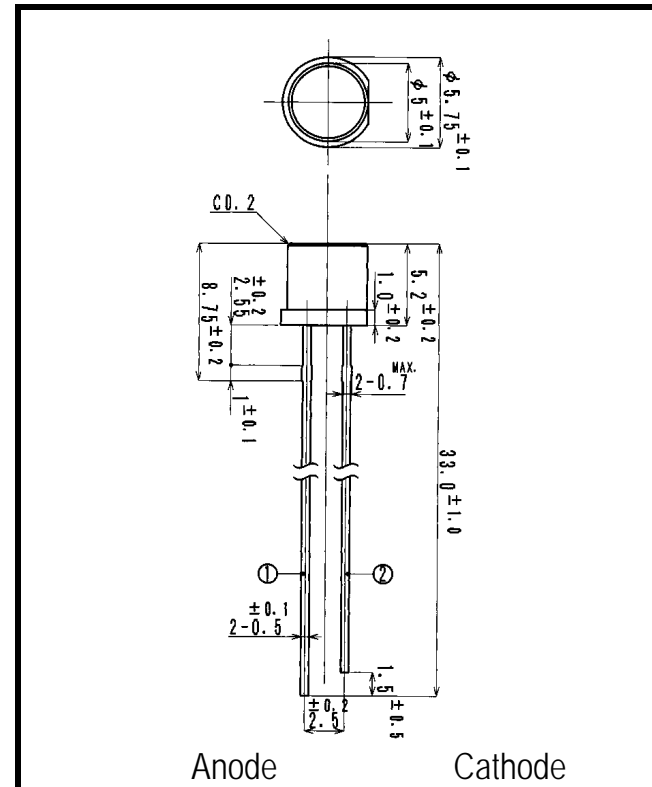

Anode Cathode  
Dimensions (Unit:mm)

- FEATURES**
- High Output Power
  - High Reliability
- APPLICATIONS**
- Optical Sensor
  - Fiber Optical Communications
  - Indicators

## 2. ELECTRICAL & OPTICAL CHARACTERISTICS (Ta=25 °C)

ITEM	SYMBOL	CONDITIONS	MIN	TYP	MAX	UNIT
Power Output	PO	IF=20mA		2.5		mW
Forward Voltage	VF	IF=20mA		3.5	4.0	V
Reverse Current	IR	VR=5V			100	μA
Peak Wavelength	λ	IF=20mA		468		nm
Spectral Line Half Width		IF=20mA		35		nm
Half Intensity Beam Angle		IF=20mA		±55		deg.
Rise Time	Tr	IFP=20mA		-		nS
Fall Time	Tf	IFP=20mA		-		nS
Junction Capacitance	Cj	1MHz, V=0V		40		pF
Temp. Coefficient of PO	P/T	IF=10mA		-0.5		%/
Temp. Coefficient of VF	V/T	IF=10mA		-3.0		mV/

SPECTRAL OUTPUT

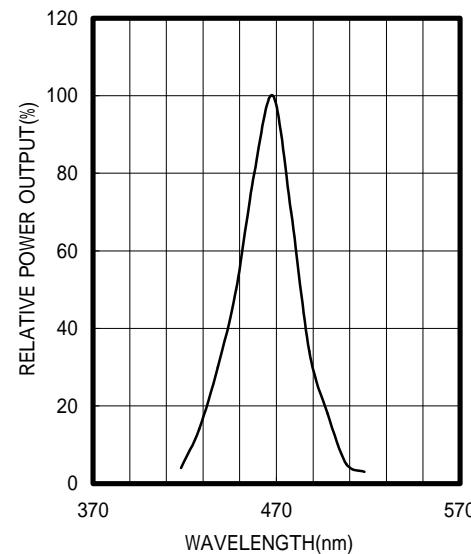

FORWARD I-V CHARACTERISTICS

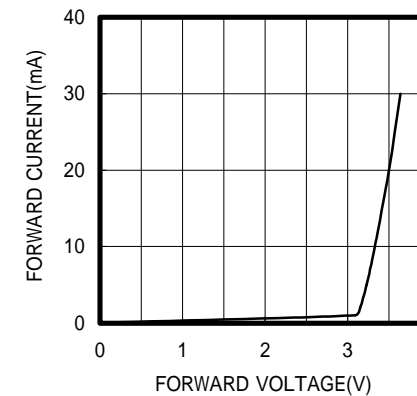

RELATIVE POWER vs FORWARD CURRENT

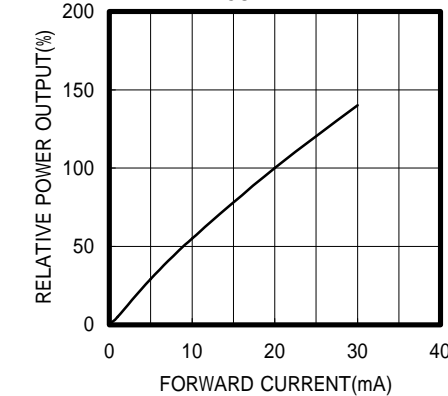

RADIATION PATTERN

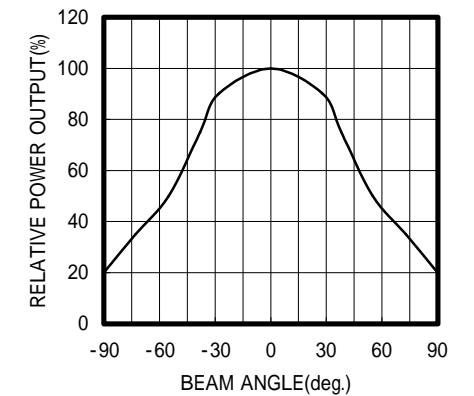

## 1. ABSOLUTE MAXIMUM RATINGS (Ta=25 °C)

ITEM	SYMBOL	RATINGS	UNIT
Forward Current (DC)	IF	30	mA
Forward Current (Pulse)*1	IFP	0.3	A
Reverse Voltage	VR	5	V
Power Dissipation	PD	120	mW
Operating Temp.	Topr	-20 TO 80	
Storage Temp.	Tstg	-30 TO 100	
Junction Temp.	Tj	100	
Lead Soldering Temp.*2	Tls	260	

\*1: Tw=10uS, T=10mS

\*2: Time 5 Sec max, Position: Up to 3mm from the body

THERMAL DERATING CURVE

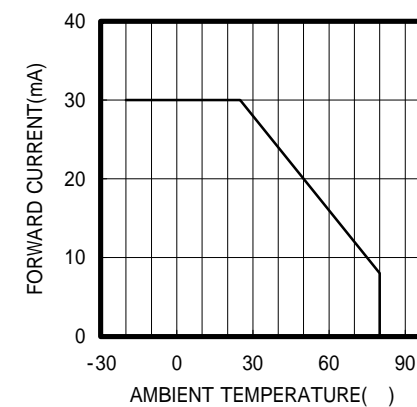

POWER OUTPUT vs TEMPERATURE IF=10mA

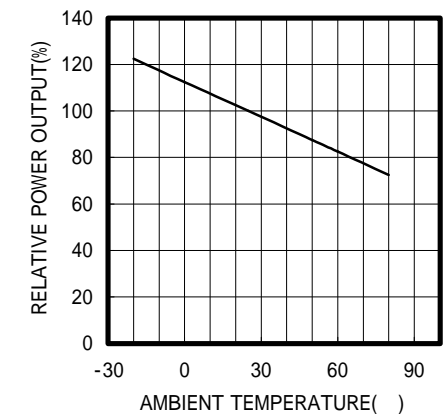

FORWARD VOLTAGE vs TEMPERATURE IF=10mA

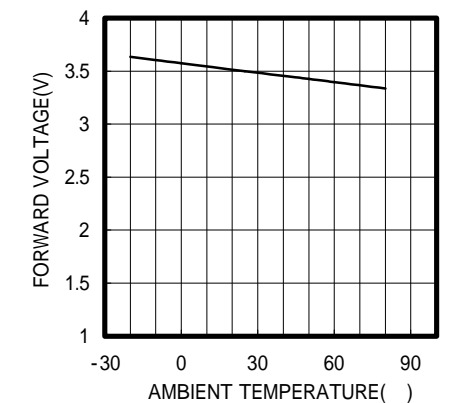

**OPTRANS**

2-6-11 MASUKATA, TAMA-KU, KAWASAKI 214-0032, JAPAN  
TEL.81(44)932-6491 / FAX.81(44)932-8281  
E-mail: oprans@mb.kcom.ne.jp