

VSF771C1

Visible Light Emitting Diode

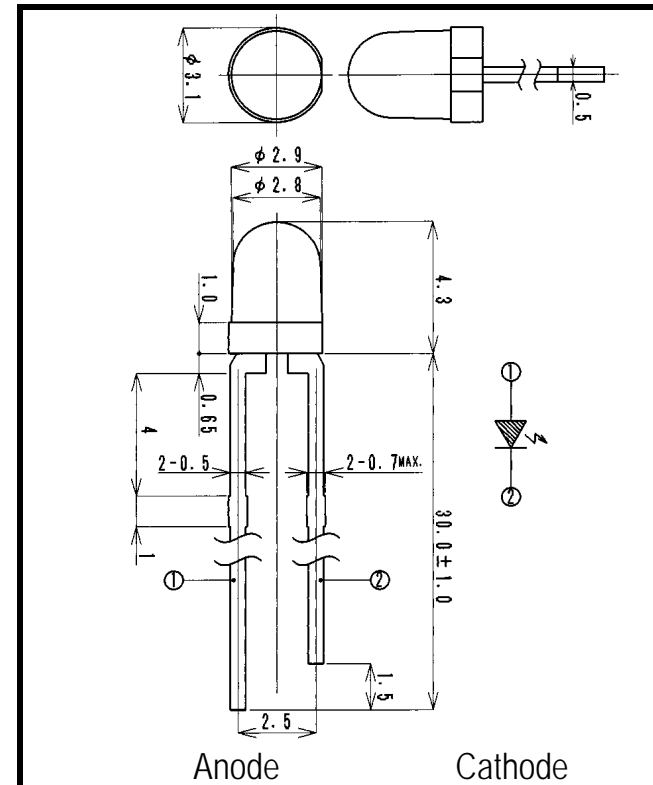
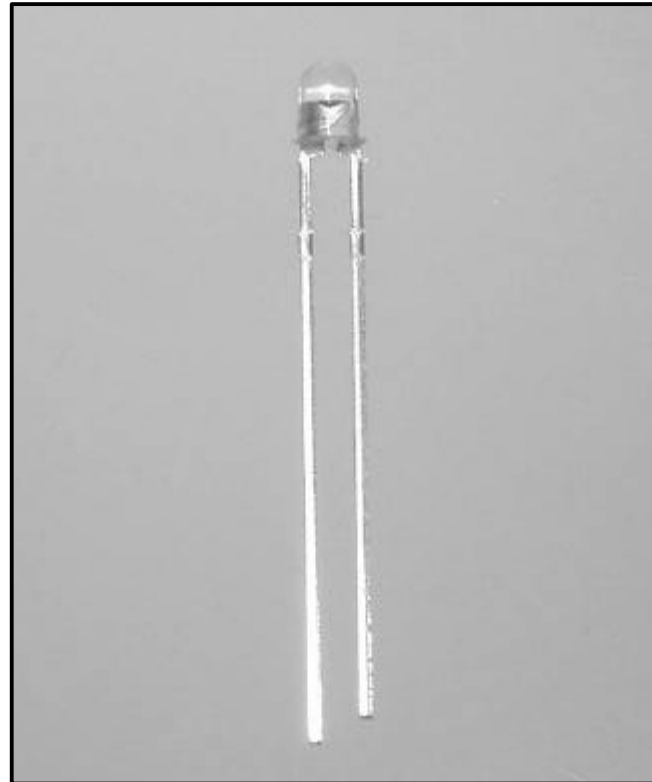

- FEATURES**
- High-output Power
 - Compact
 - High Reliability
- APPLICATIONS**
- Optical Switches
 - Optical Sensors
 - Medical Application

2. ELECTRICAL & OPTICAL CHARACTERISTICS (Ta=25 °C)

ITEM	SYMBOL	CONDITIONS	MIN	TYP	MAX	UNIT
Power Output	PO	IF=20mA		6.0		mW
Forward Voltage	VF	IF=20mA		1.55	1.95	V
Reverse Current	IR	VR=5V			100	μA
Peak Wavelength	λ	IF=20mA		770		nm
Spectral Line Half Width		IF=20mA		25		nm
Half Intensity Beam Angle		IF=20mA		±25		deg.
Rise Time	Tr	IFP=20mA		-		nS
Fall Time	Tf	IFP=20mA		-		nS
Junction Capacitance	Cj	1MHz, V=0V		35		pF
Temp. Coefficient of PO	P/T	IF=10mA		-0.6		%/°C
Temp. Coefficient of VF	V/T	IF=10mA		-2.0		mV/°C

1. ABSOLUTE MAXIMUM RATINGS (Ta=25 °C)

ITEM	SYMBOL	RATINGS	UNIT
Forward Current (DC)	IF	50	mA
Forward Current (Pulse)*1	IFP	0.5	A
Reverse Voltage	VR	5	V
Power Dissipation	PD	100	mW
Operating Temp.	Topr	-20 TO 85	
Storage Temp.	Tstg	-30 TO 100	
Junction Temp.	Tj	100	
Lead Soldering Temp.*2	Tls	260	

*1: Tw=10μs, T=10mS

*2: Time 5 Sec max, Position: Up to 3mm from the body

SPECTRAL OUTPUT

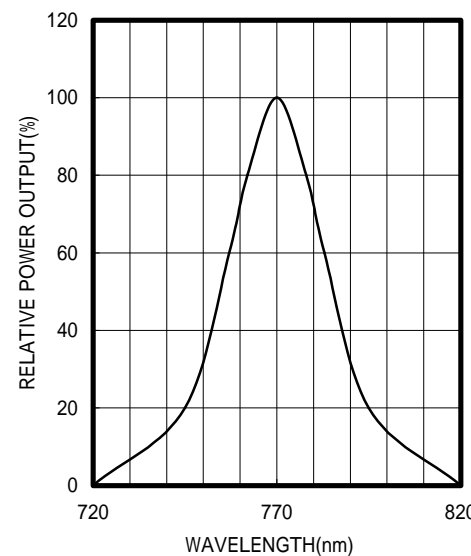

FORWARD I-V CHARACTERISTICS

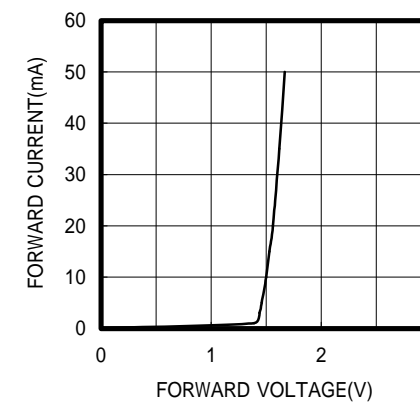

RELATIVE POWER vs FORWARD CURRENT

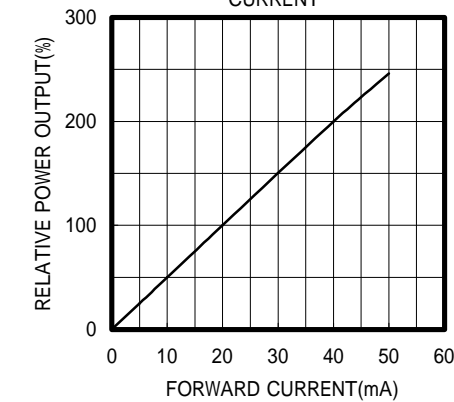

RADIATION PATTERN

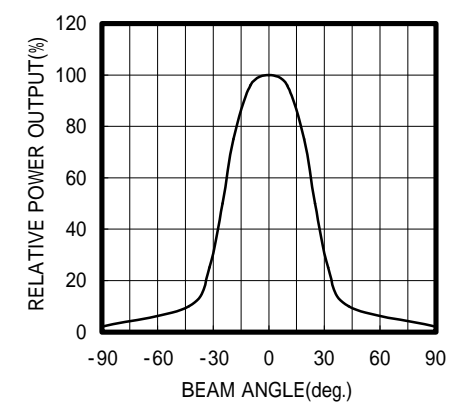

THERMAL DERATING CURVE

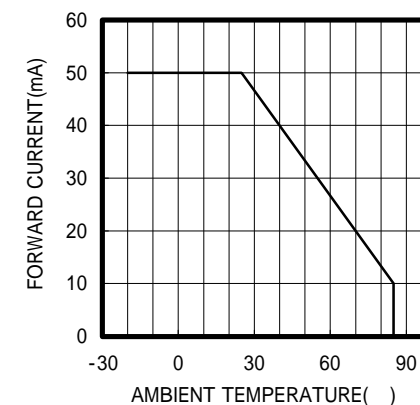

POWER OUTPUT vs TEMPERATURE IF=10mA

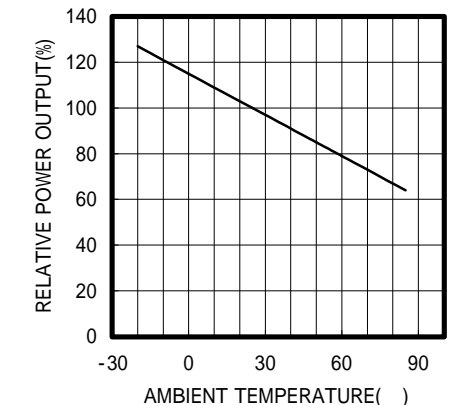

FORWARD VOLTAGE vs TEMPERATURE IF=10mA

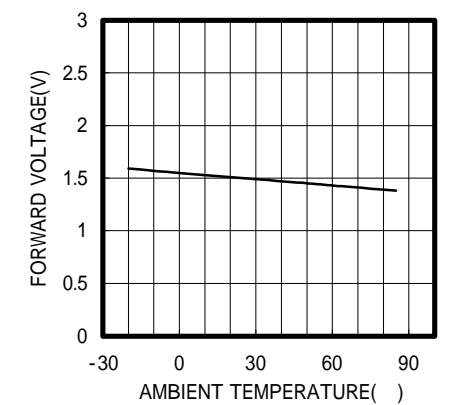

OPTRANS

2-6-11 MASUKATA, TAMA-KU, KAWASAKI 214-0032, JAPAN
 TEL.81(44)932-6491 / FAX.81(44)932-8281
 E-mail optrans@mb.kcom.ne.jp